

Mepla ø 16 / 20 / 26

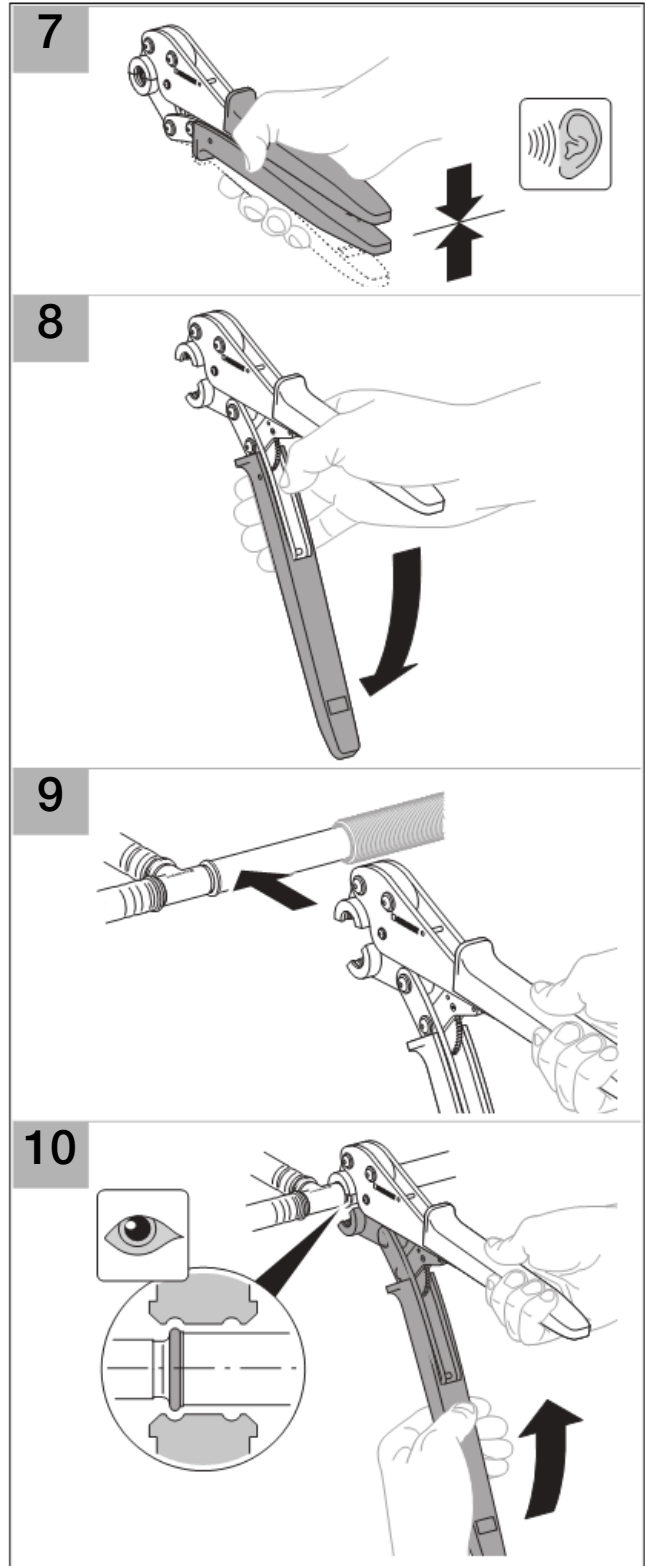

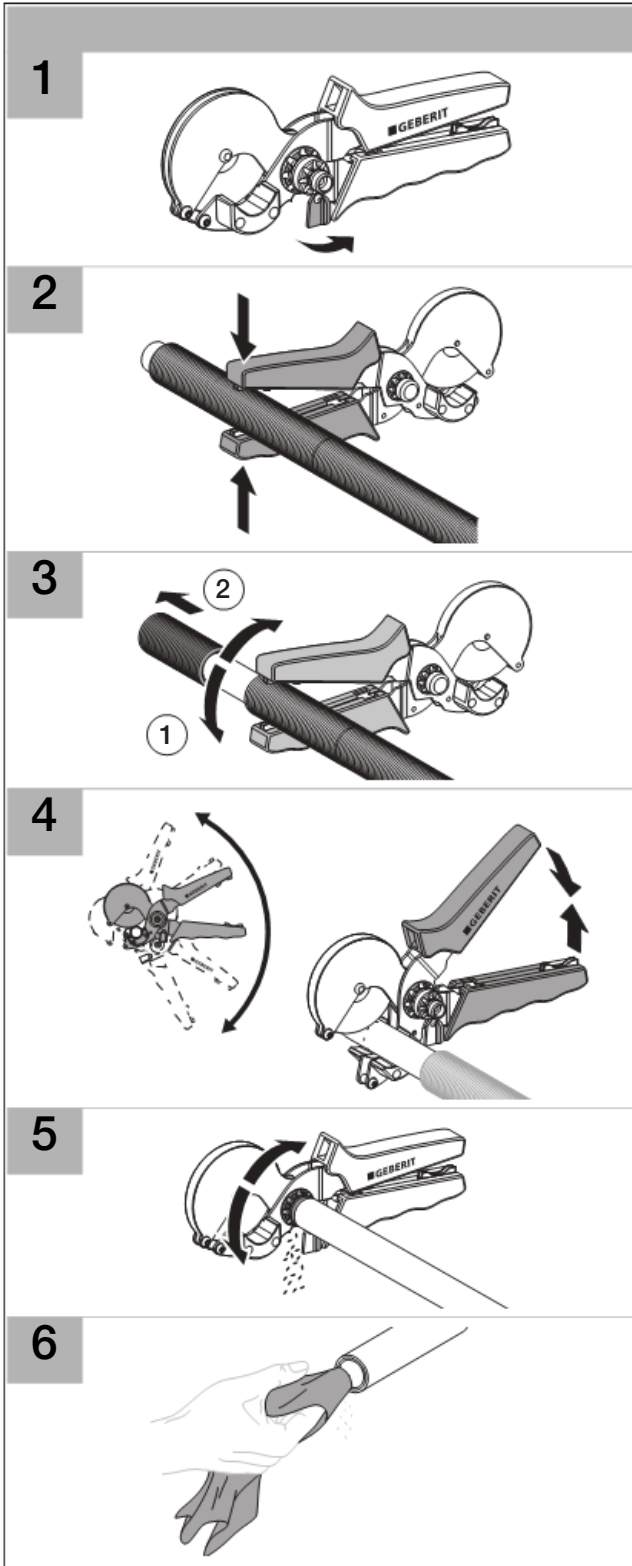

- DE** Lösen einer versehentlich eingeleiteten Verpressung
EN Releasing a pressing operation made by mistake
FR Desserrement d'une compression commencée par mégarde
IT Eliminazione di una compressione eseguita per errore
NL Losmaken van een per ongeluk gestarte persing
ES Cómo soltar una compresión iniciada por equivocación
PT Soltar uma compressão iniciada acidentalmente
DK Udbedr fejlen ved en komprimering der er blevet foretaget ved en fejltagelse
NO Løsne en pressing som er startet i vanvare
SE Lossa en oavsiktligt påbörjad pressning
FI Vahingossa aloitetun puristuksen keskeyttäminen
IS Losað um þrýstingingu sem gerð hefur verið fyrir mistök
PL Poluzowanie omyłkowo zaciśniętego złącza
HU A tévesen megkezdett préskötés kioldása
SK Uvoľnenie omylom začatého lisovania
CZ Uvolnění omylem zahájeného lisování
SL Demontaža nepravilno narejenega spoja
HR Otpuštanje pogrešno uvedenog stiskanja
SR Popuštanje greškom započetog stiskanja
EE Kogemata alustatud pressingu tühistamine
LV Nepareizi savienota blīvējuma atvienošana
LT Netinkamai pradėto presavimo proceso nutraukimas
BG Отпускане на случайно започнато притискане
RO Desfacerea unei presări inițiate accidental
GR Λύσιμο μιας κατά λάθος αρχινισμένης συμπίεσης
TR İstenmeden başlatılan bir preslemenin çözümlenmesi
RU Разъединение ошибочно установленного прессового соединения
AE فك عمليّة الكبس التي بدأت سهواً
CN 松开无意中错误引发的挤压
JP 誤ってプレスした部分を緩めます。

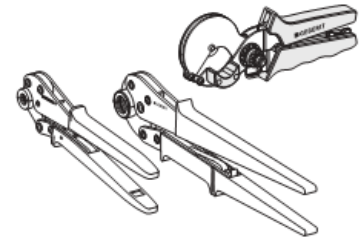
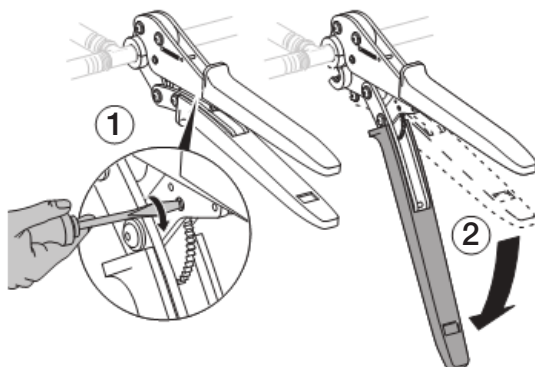

11 Mepla ø 16 / 20

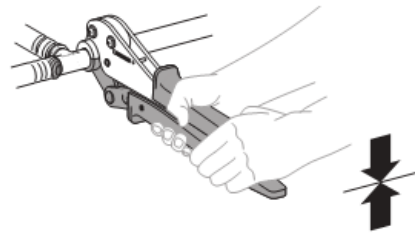

Mepla ø 26

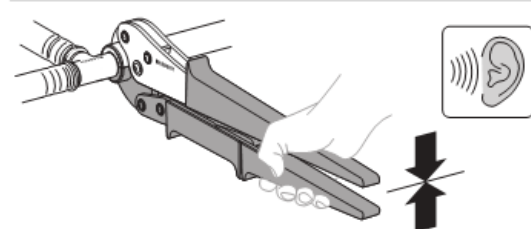
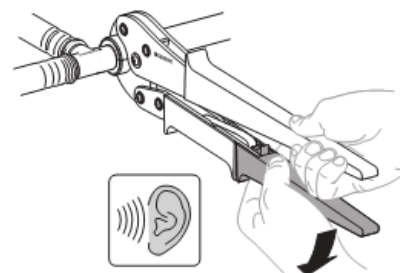
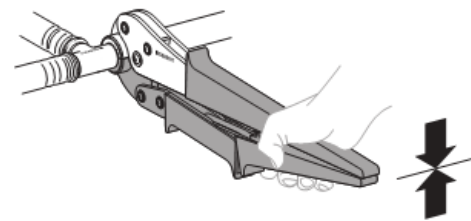
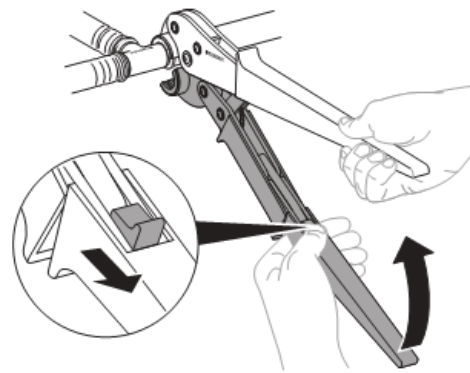

12

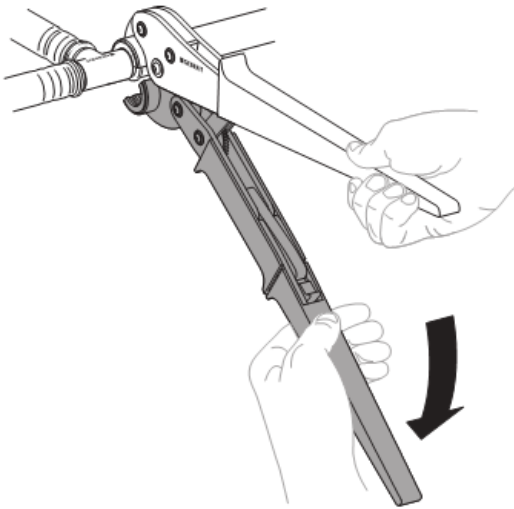

13

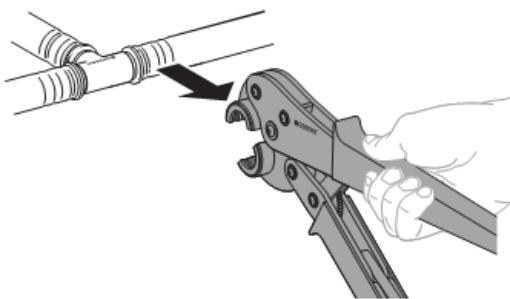

Maintenance

1

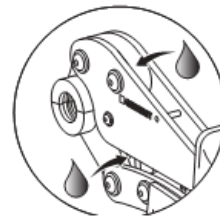

2

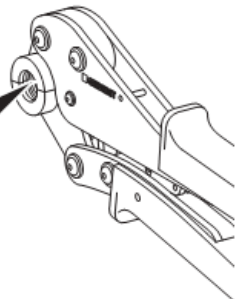
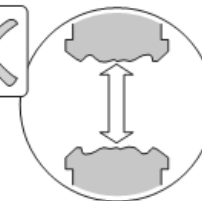
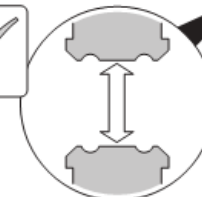

3

Mepla PowerTest

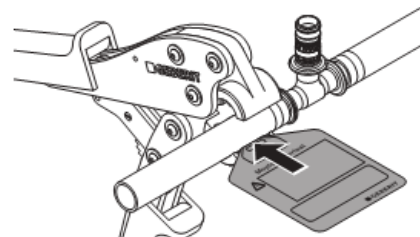
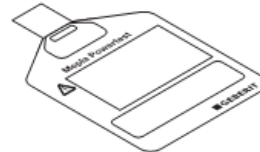



Geberit International AG
Schachenstrasse 77
CH-8645 Jona
www.geberit.com
dokumentation@geberit.com

D38353-001&BDC © 08-2009